



**PETKUS**

# **Grain Management Strategy for Safe Food in Times of Crisis**

**Dr. Khaled Raed**

**CIO PETKUS Technologie GmbH  
Managing Director PETKUS Mena**

# Volatile Market | Covid Pandemic

**7-15x**

**Inflation**  
for components



**5x**

higher costs  
for transports

**10x**

longer delivery times  
for components

Steel prices  
increased by

**83%**

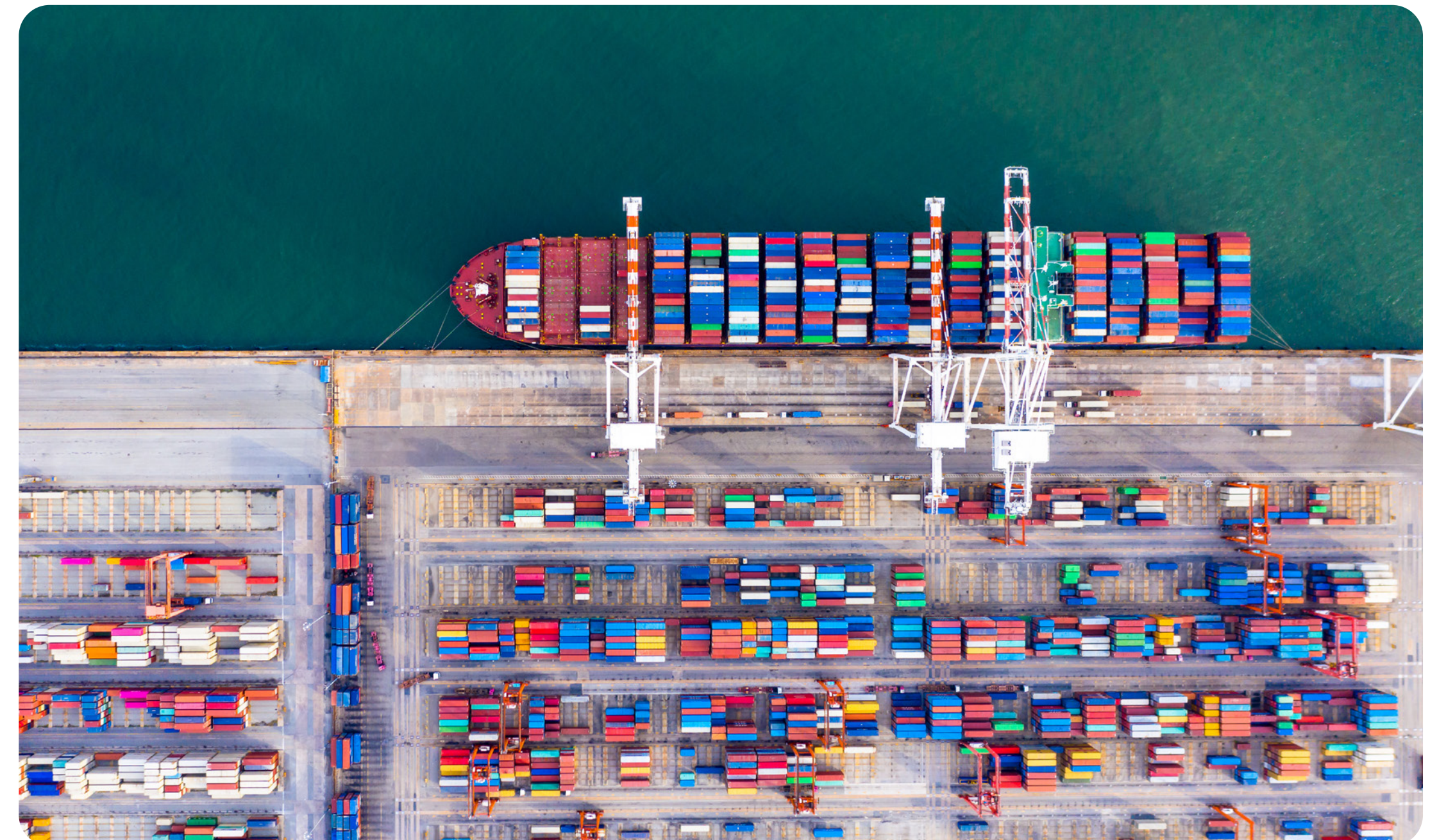

# Volatile Market | War in Ukraine

Ukrainian grain production & exports will likely fall by

**35 M tons**



**20-30%**  
of winter cereals, maize and sunflower  
in Ukraine will either not be planted or remain unharvested



International food and feed prices could rise by up to

**20%**



**Delay, re-route,  
possible reduction**  
of Russian grain exports

# Iranian Import Dependency

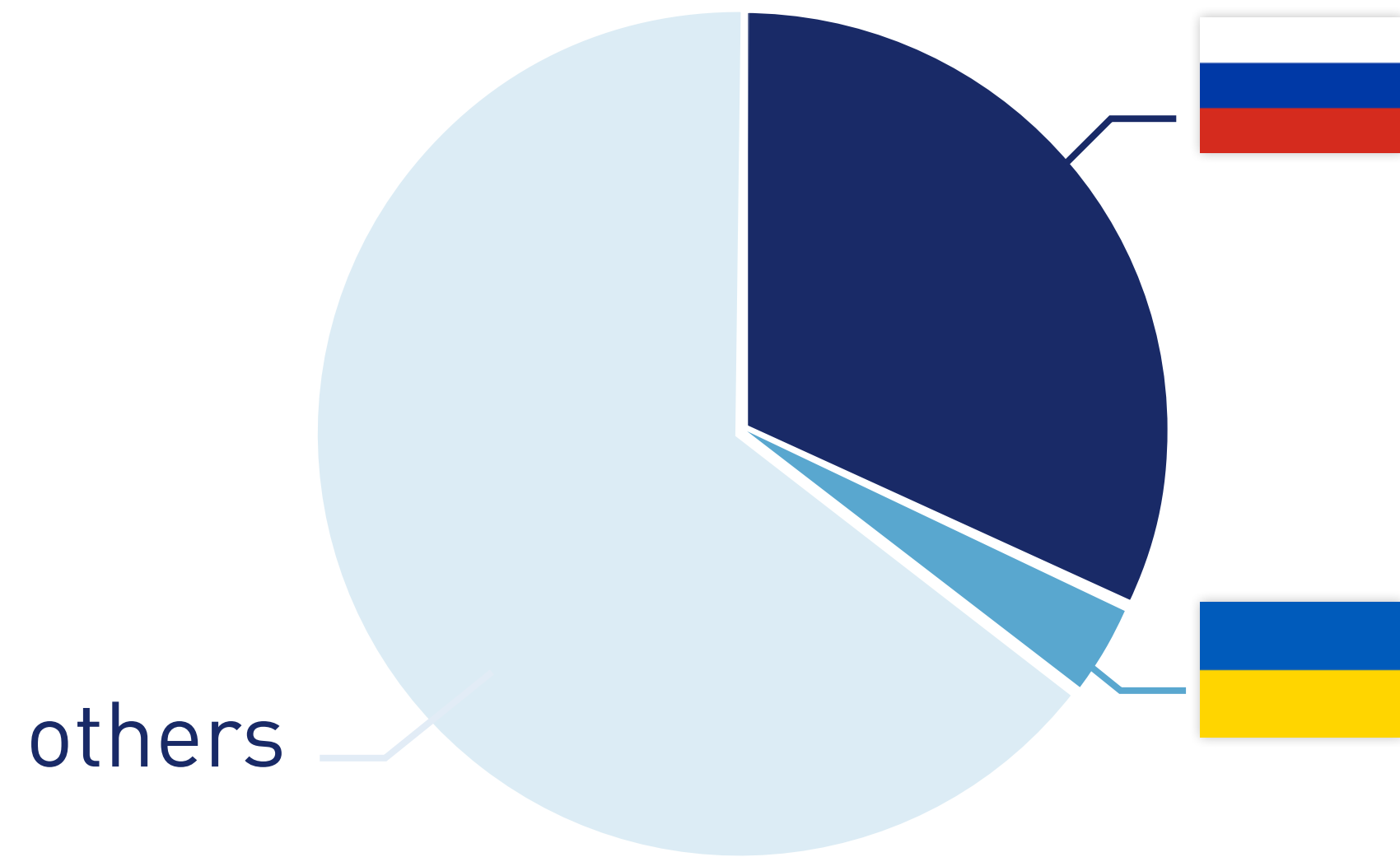

7 Mio t of wheat imports

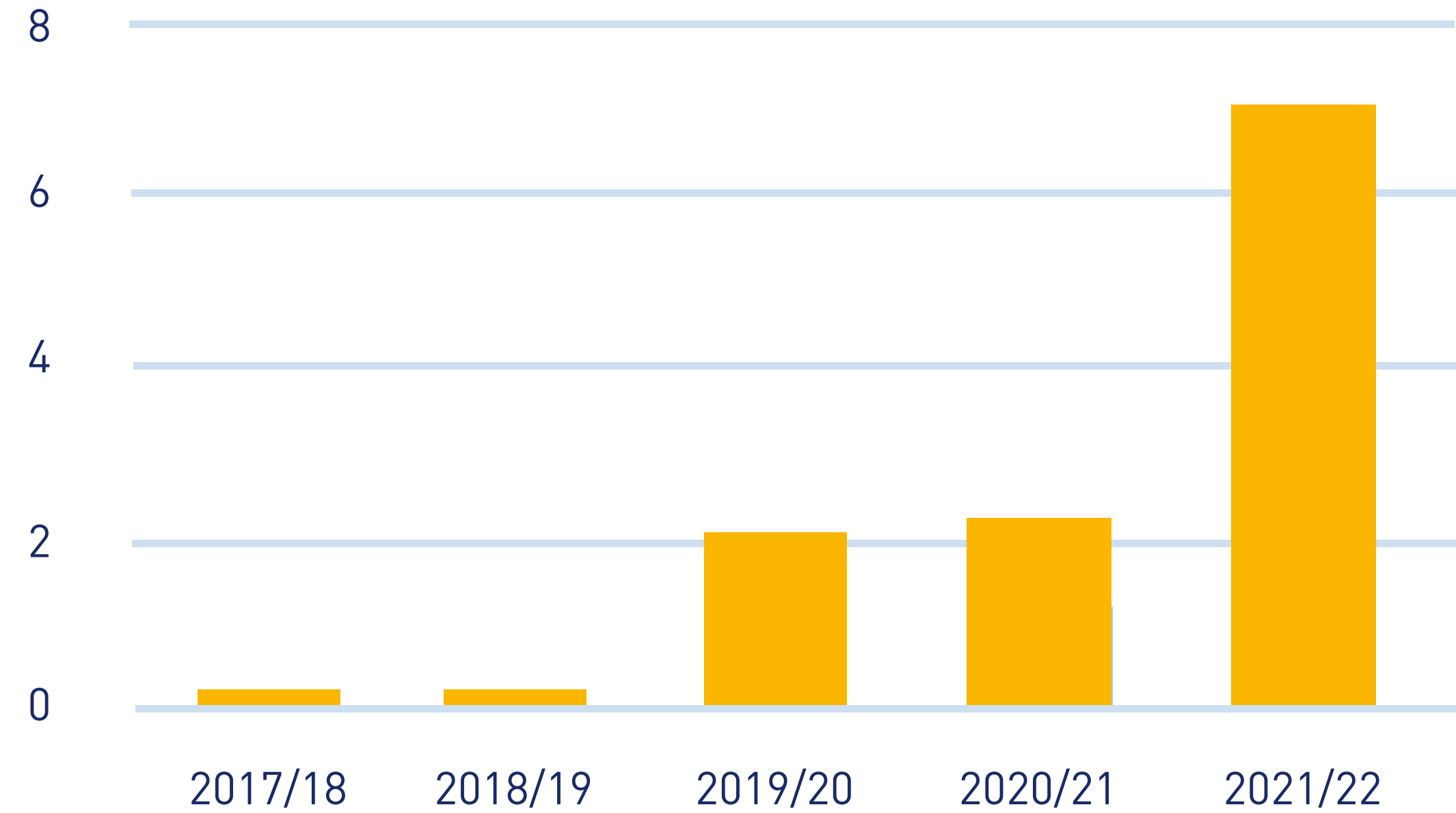

Wheat Import Surge (Million MT)

**15.7 M tons**  
Food, Seed, Industrial  
Wheat Consumption  
in 2021

**20%**  
decrease in rainfall  
over the last century

**30%**  
of wheat harvest  
lost in 2021  
due to drought

Grain must be handled with the utmost care.

**Reduce  
losses**

**Improve  
quality**

**Proper  
technology**

**Enhance  
food safety**

# The threats for healthy grain



**Poor grain  
cleaning**

**Poor  
storage**

**Fungal  
mold**

**Mycotoxins**



**Mycotoxins**

**25%**  
of crops worldwide  
are contaminated with  
mycotoxins



## **Safe food starts by protecting food crops from contamination**

**Proper  
cleaning**

**Proper  
drying**

**Proper  
storage**





**PROPER  
CLEANING**

# X Cleaner gives your Grain Power



- Processing 80-300 t/h
- Pre- and intensive cleaning
- Large screen area on small footprint
- Ingenious grain cleaning concept

# Airmax Technology

- good product
- light material
- half grains
- equal sized grains with lower weight

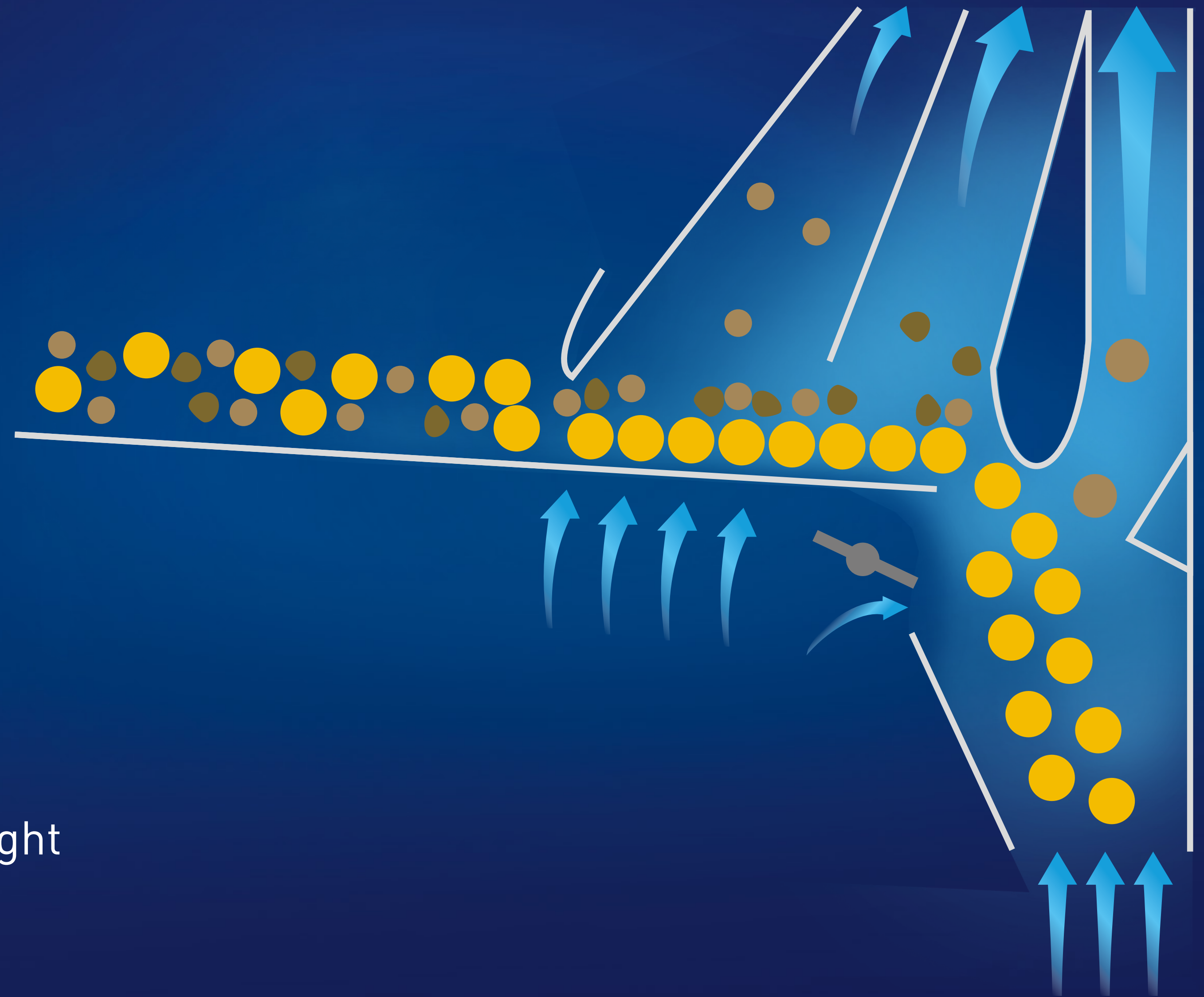

# X Cleaner

Strong  
Aspiration  
Outlet



Pre-scalper  
and scraper  
chain

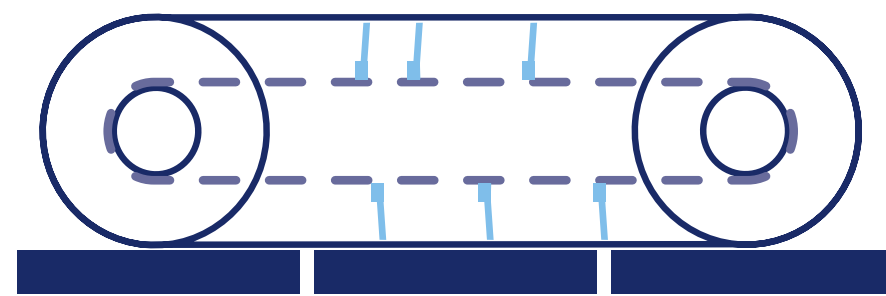

Linear  
oscillation

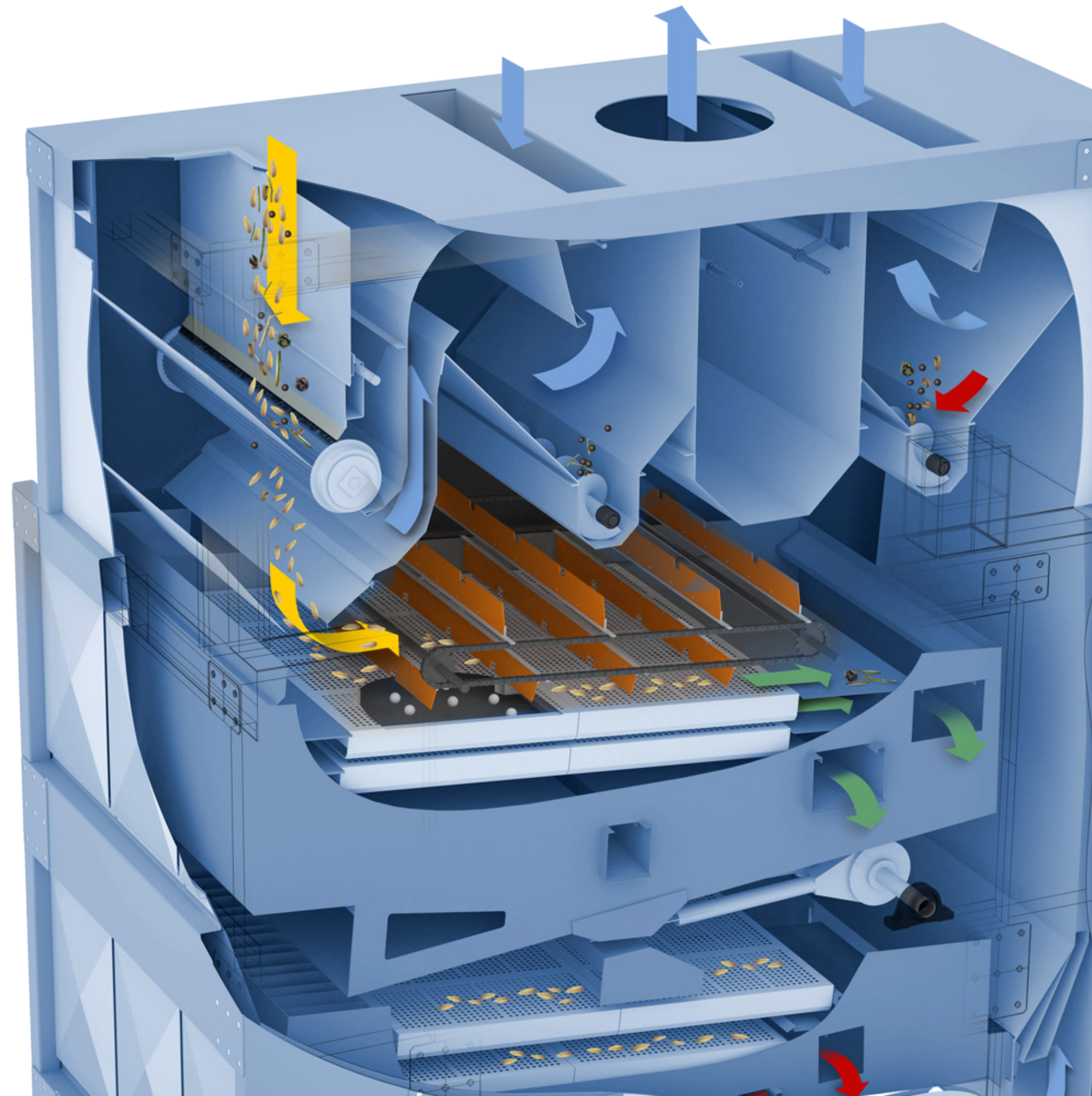
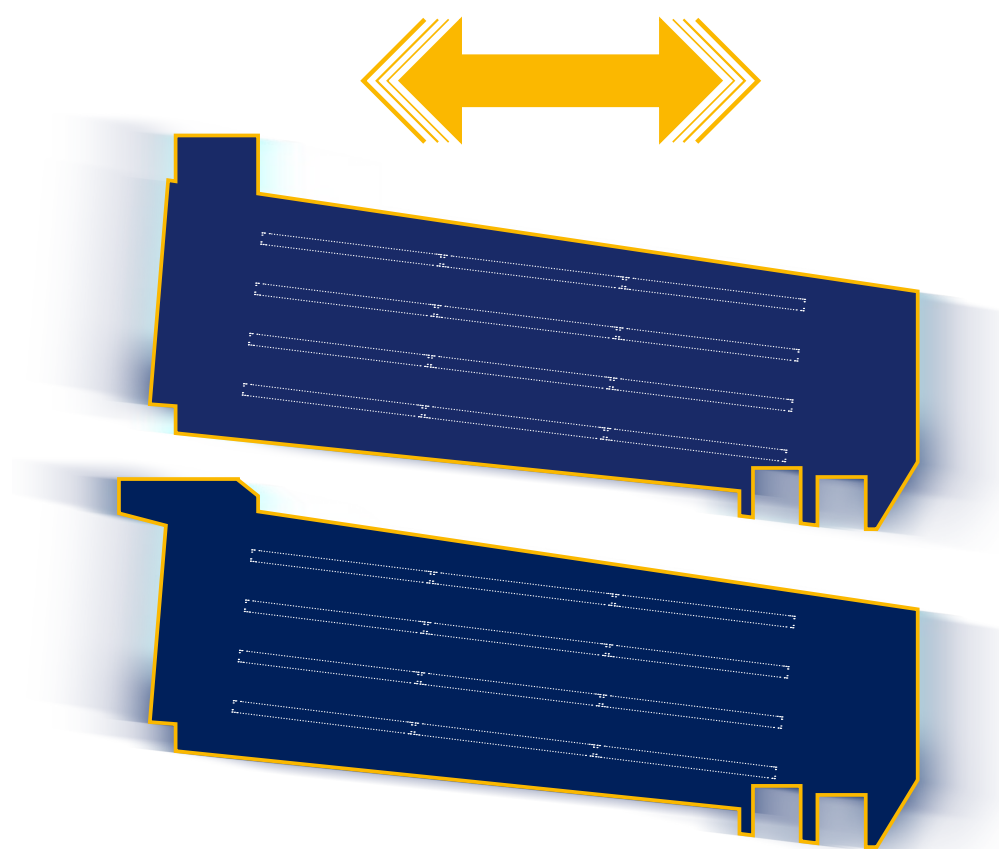

# Optical Sorter

**SEE MORE** than you can see



**PETKUS**  
transmission  
technology

# OS t See more than you can see



RGB

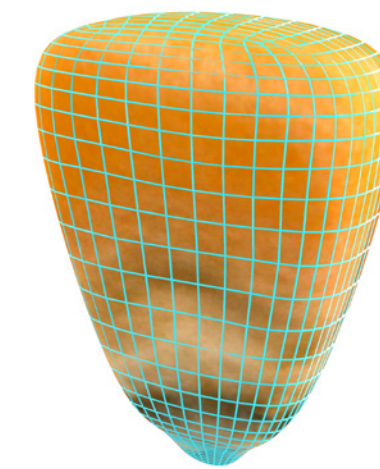

Geometry

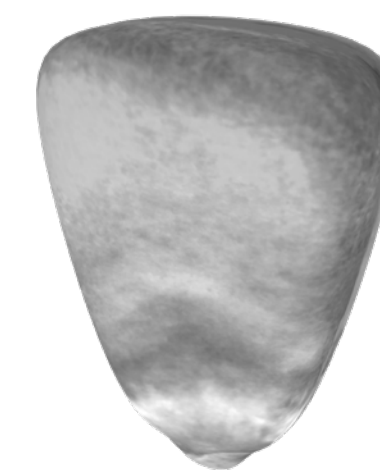

Infrared



Transmission

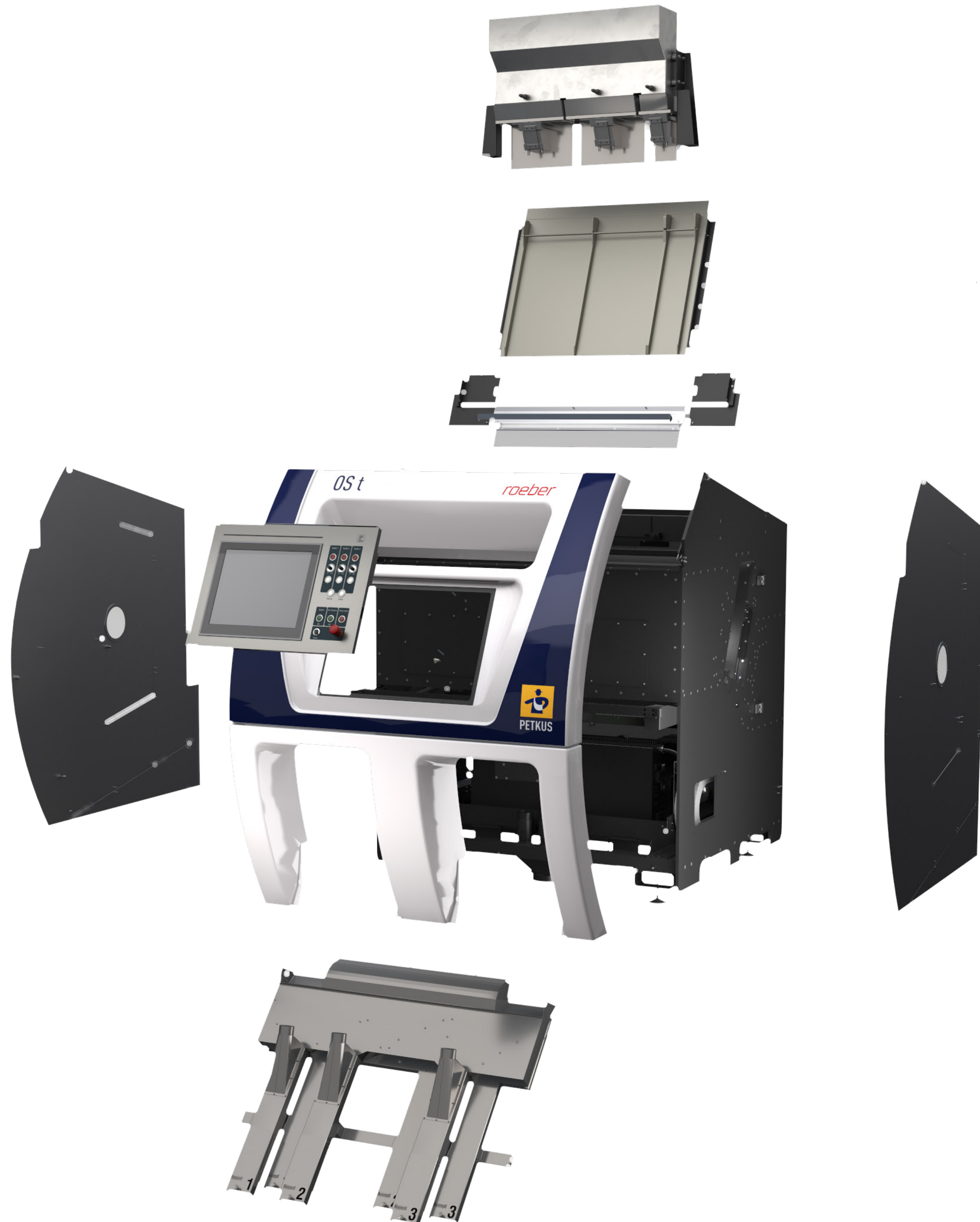

## High Quality Engineering

Made **In Germany**

- High performance LEDs
- 99% sorting accuracy
- Intelligent teach-in



# Mechanical Cleaning



	Raw material	Pre-cleaning
Deoxynivalenol (DON)	48 µg / kg	<10 µg / kg
Aflatoxin B1	1.1 µg / kg	<0.1 µg / kg







# Mechanical & Optical Cleaning



	Raw material	Mechanical cleaning	Optical sorting
Deoxynivalenol (DON)	1050 ppb	800 ppb	440 ppb

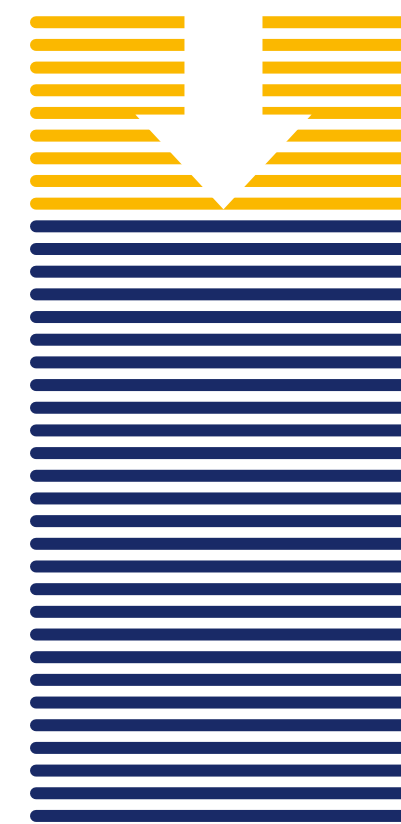

24%

**DON REDUCTION**  
after mechanical cleaning



62%

**DON REDUCTION**  
after optical sorting



  
PETKUS

**PROPER  
DRYING**



## Continuous Flow Dryer

- Energy efficient
- Gentle and even drying
- High thermal capacity and efficiency

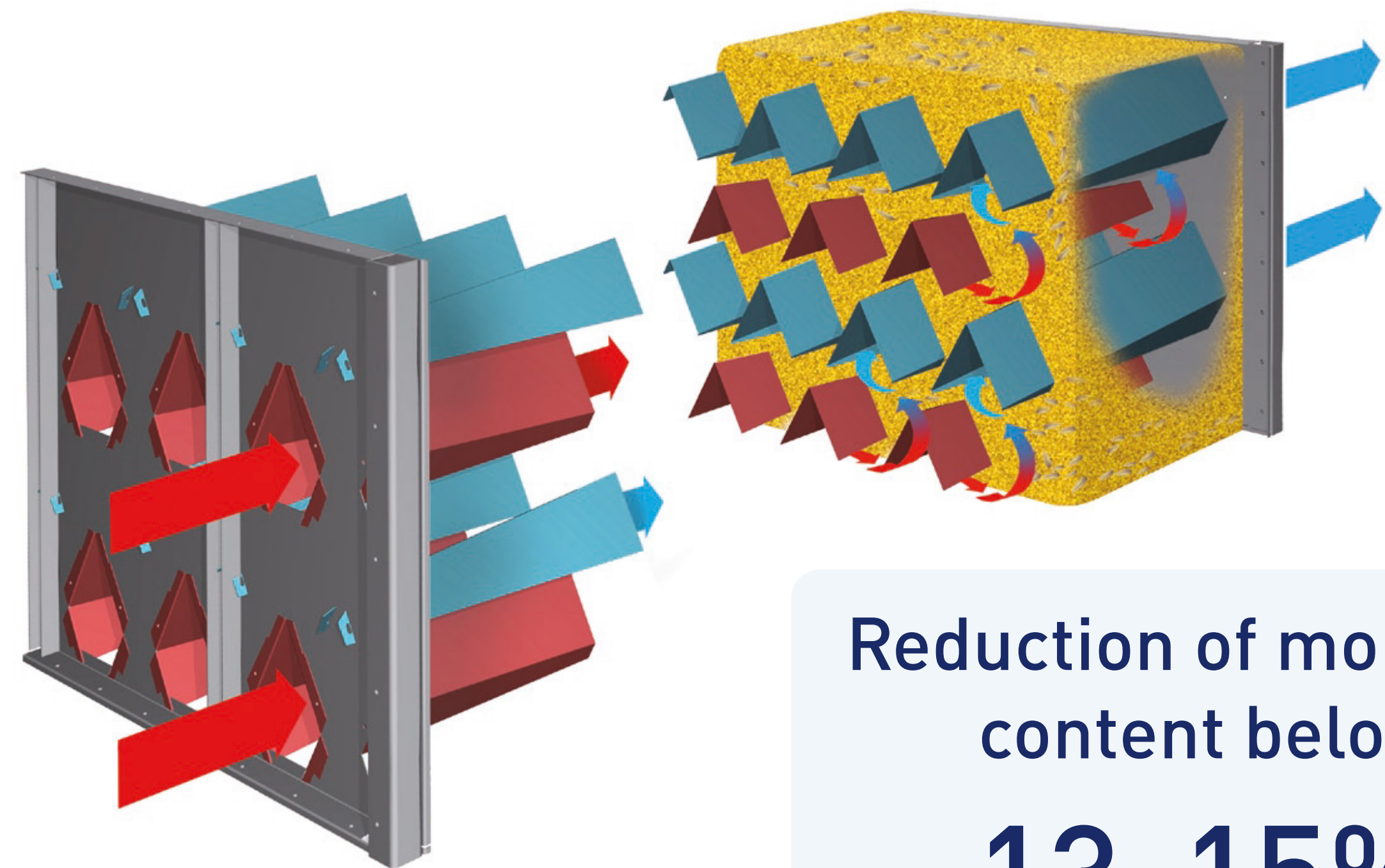

Reduction of moisture  
content below

**13-15%**



# PROPER STORAGE

Your grain  
is your bank

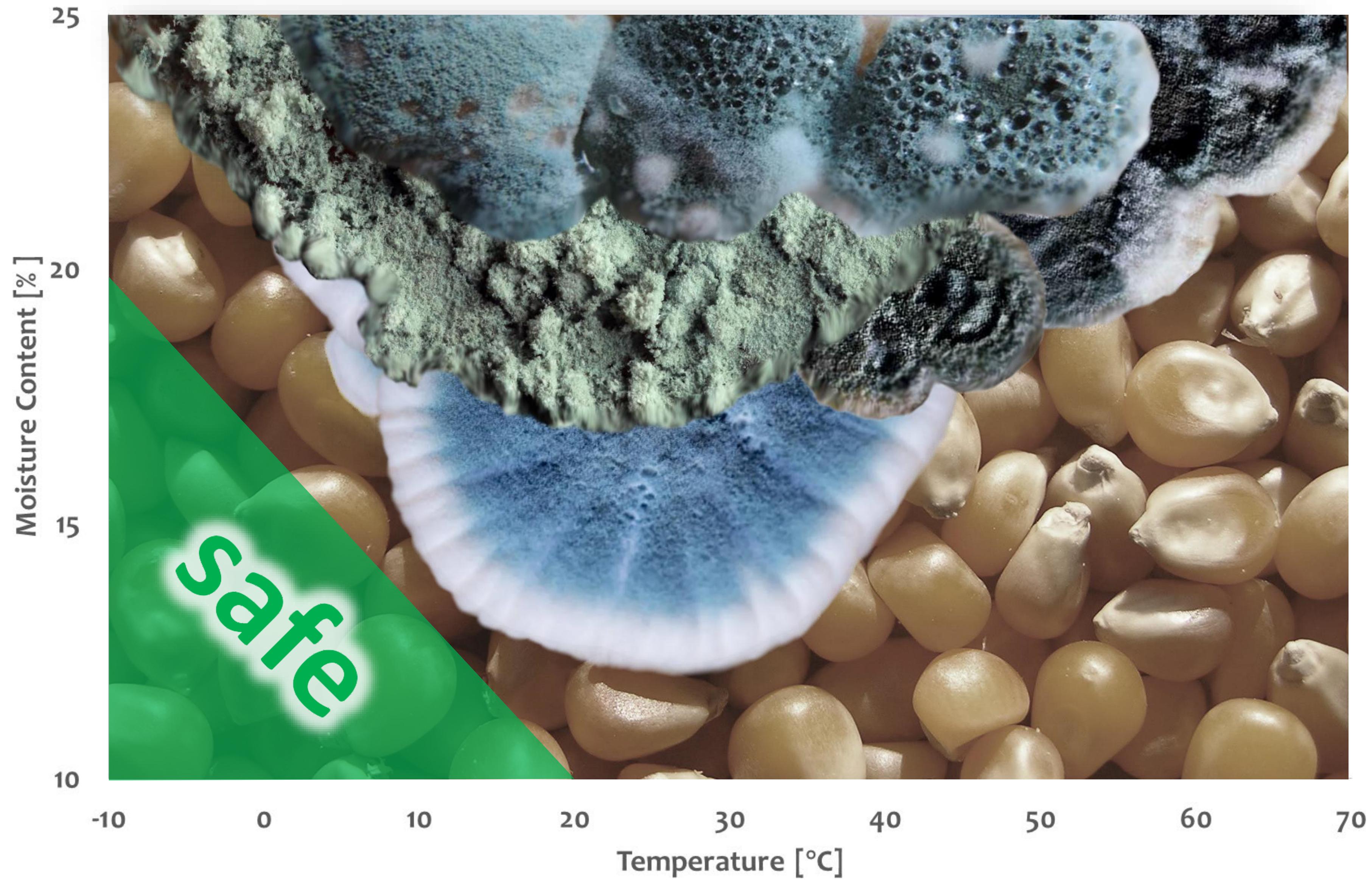

**Aeration  
is key to  
food safety**

Storing grain  
**below 12°C**  
to hinder aflatoxin production

Temperature  
monitoring

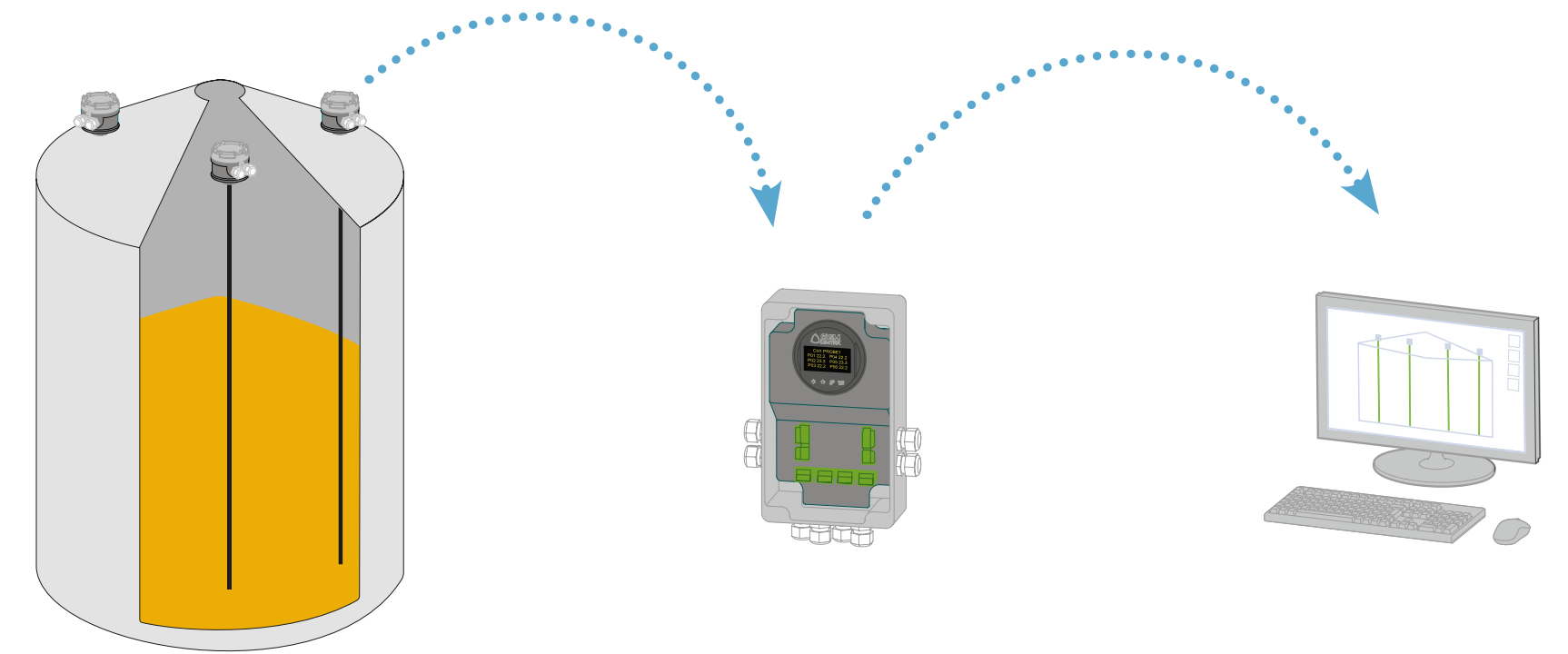

Roof ventilation



Ventilation Channels

# Grain Chiller

- No risk of insects
- No risk of fungal growth & Mycotoxins
- Minimized respiration losses



Ideal storage  
temperature

**1-4°C**

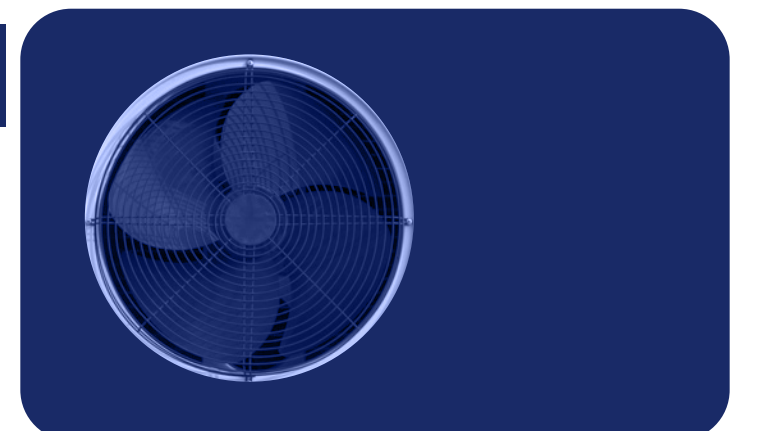

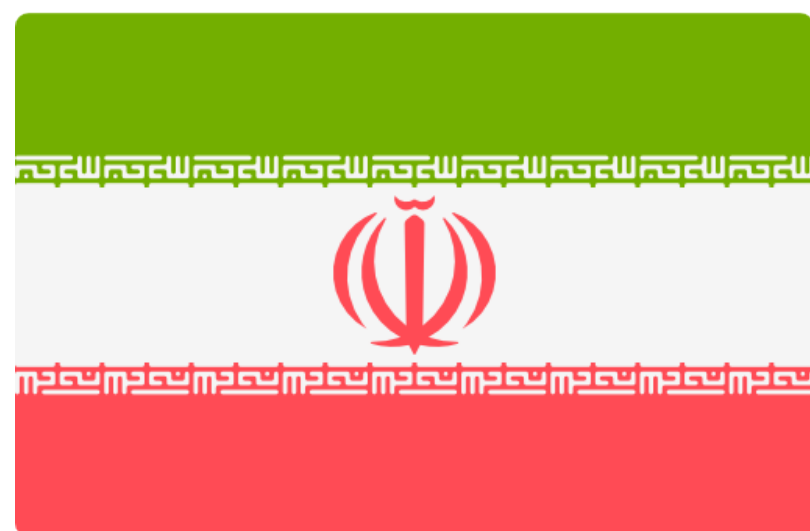

Mehr Sanat Fidar



PETKUS Mena



**PETKUS**

**For your safe food.**



**Strong Seed. Healthy Grain.**