

مزایای پیش بوجاری گندم

- ▶ جداسازی ناخالصی های درشت ، کزل و خاک گندم
- ▶ جلوگیری از آسیب ماشین آلات و انتقال دهنده ها
- ▶ افزایش فضای ذخیره سازی
- ▶ جلوگیری از فساد گندم در سیلوها
- ▶ کاهش خطر انفجار ناشی از گرد و غبار گندم

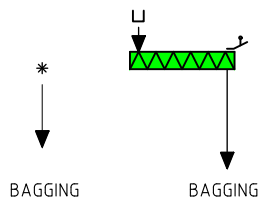
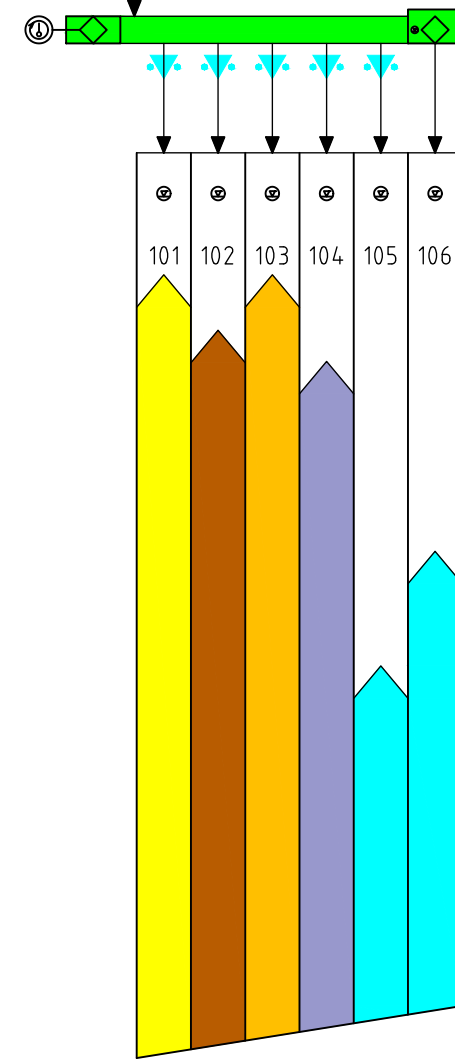
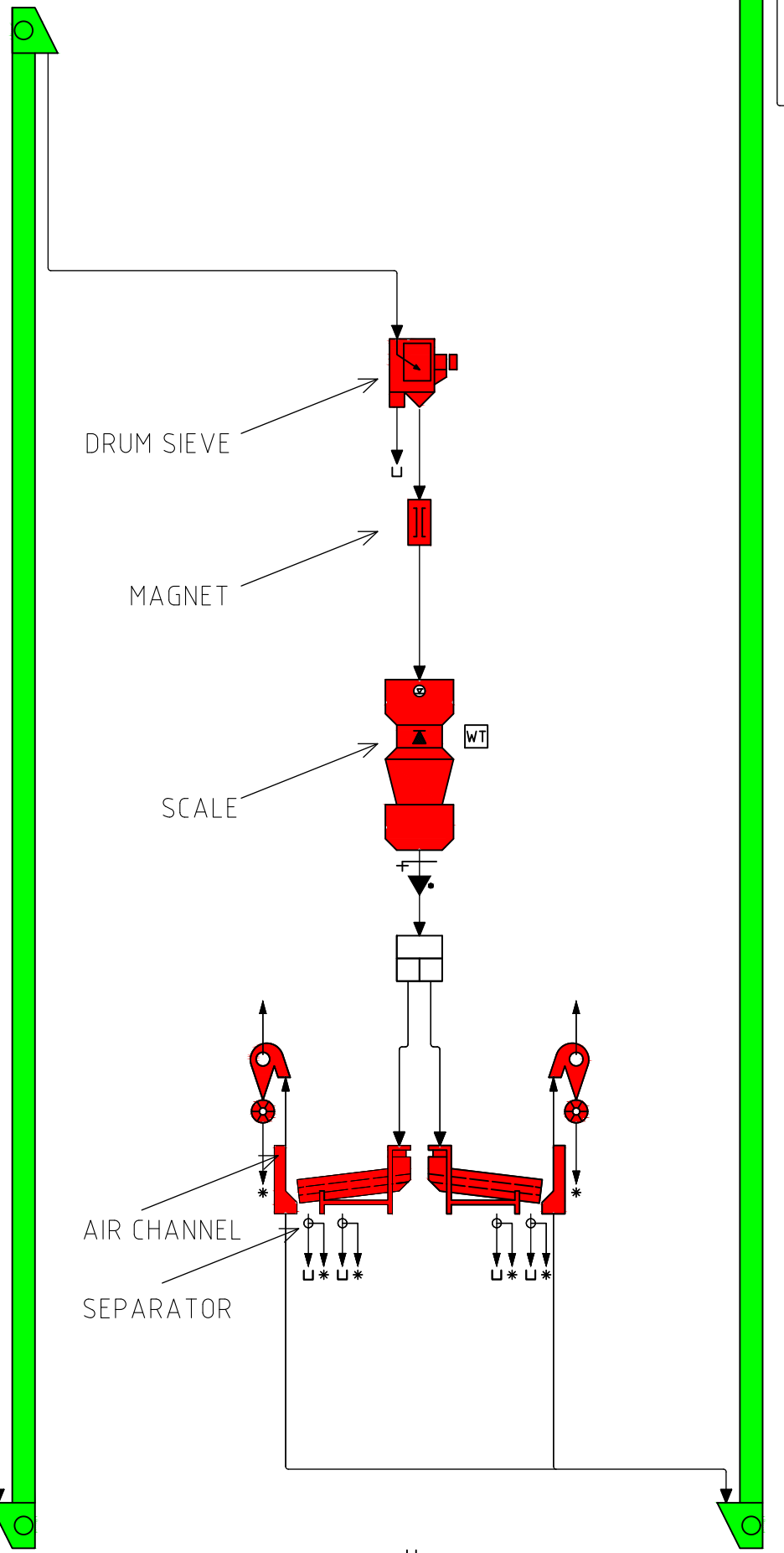
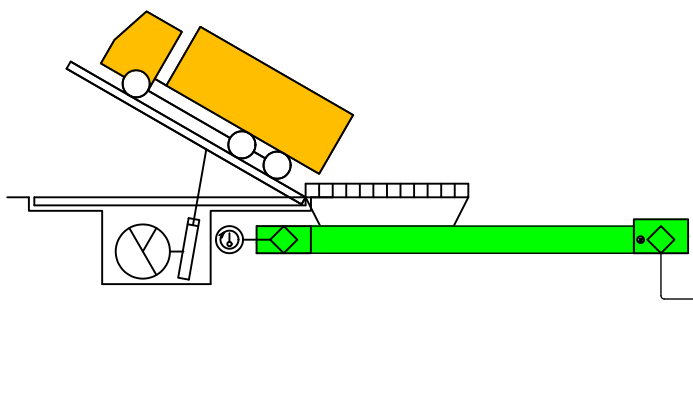
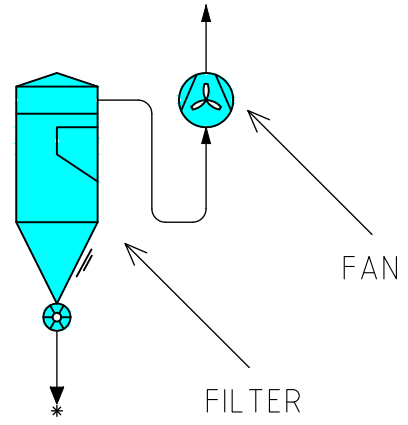

PRE CLEANING

ماشین آلات بخش بوجاری

- ▶ جداسازی بر اساس اندازه در سپراتورها و کمبیناتور
- ▶ جداسازی بر اساس مقاومت هوا در کانال های هوا
- ▶ جداسازی بر اساس وزن مخصوص در شن گیر و کمبیناتور
- ▶ جداسازی بر اساس خاصیت مغناطیسی در آهنربا
- ▶ جداسازی بر اساس شکل کروی در سیاه دانه گیر
- ▶ جداسازی بر اساس طول مرکز ثقل در تریور
- ▶ جداسازی بر اساس رنگ در سورتکس
- ▶ کاهش آلودگی سطح گندم و بار میکروبی در پوست گیرها

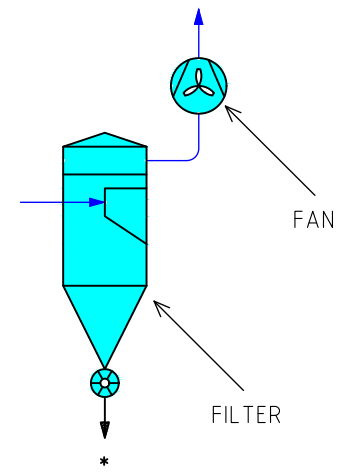
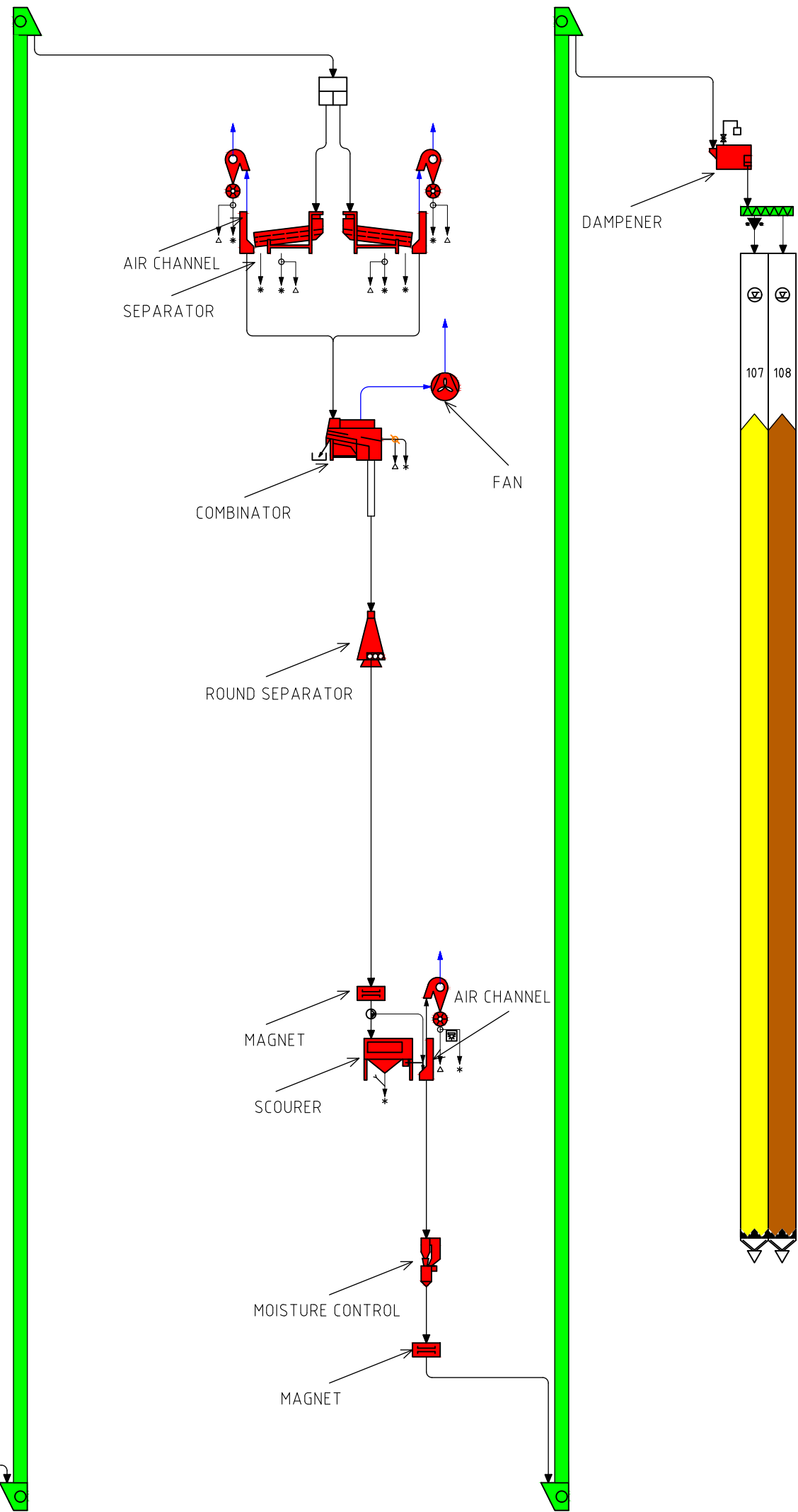
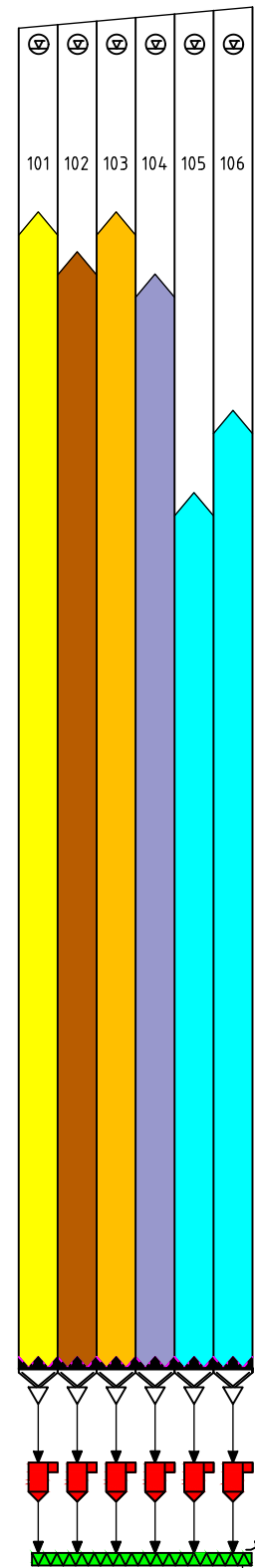

FIRST CLEANING

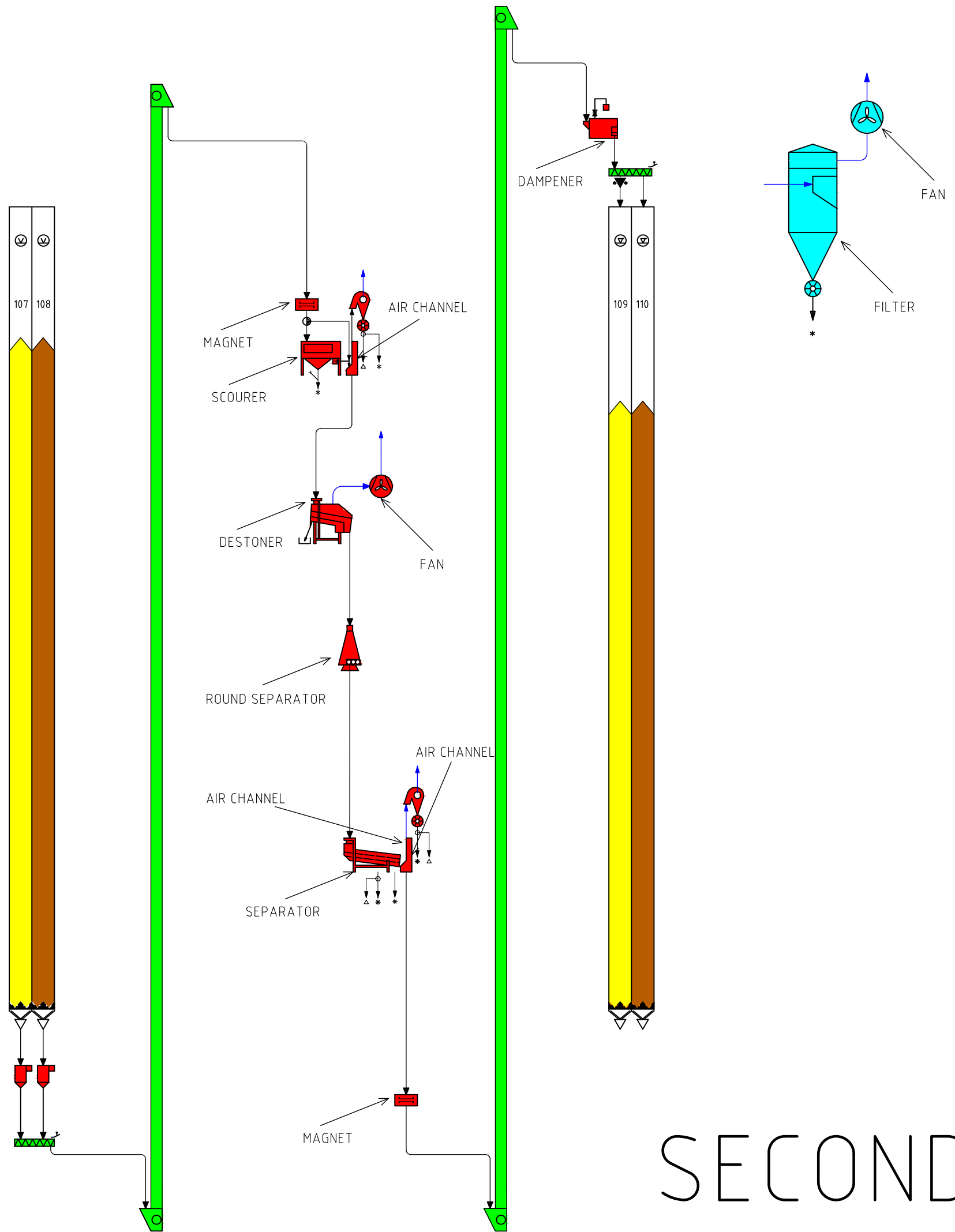

SECOND DAMPENING

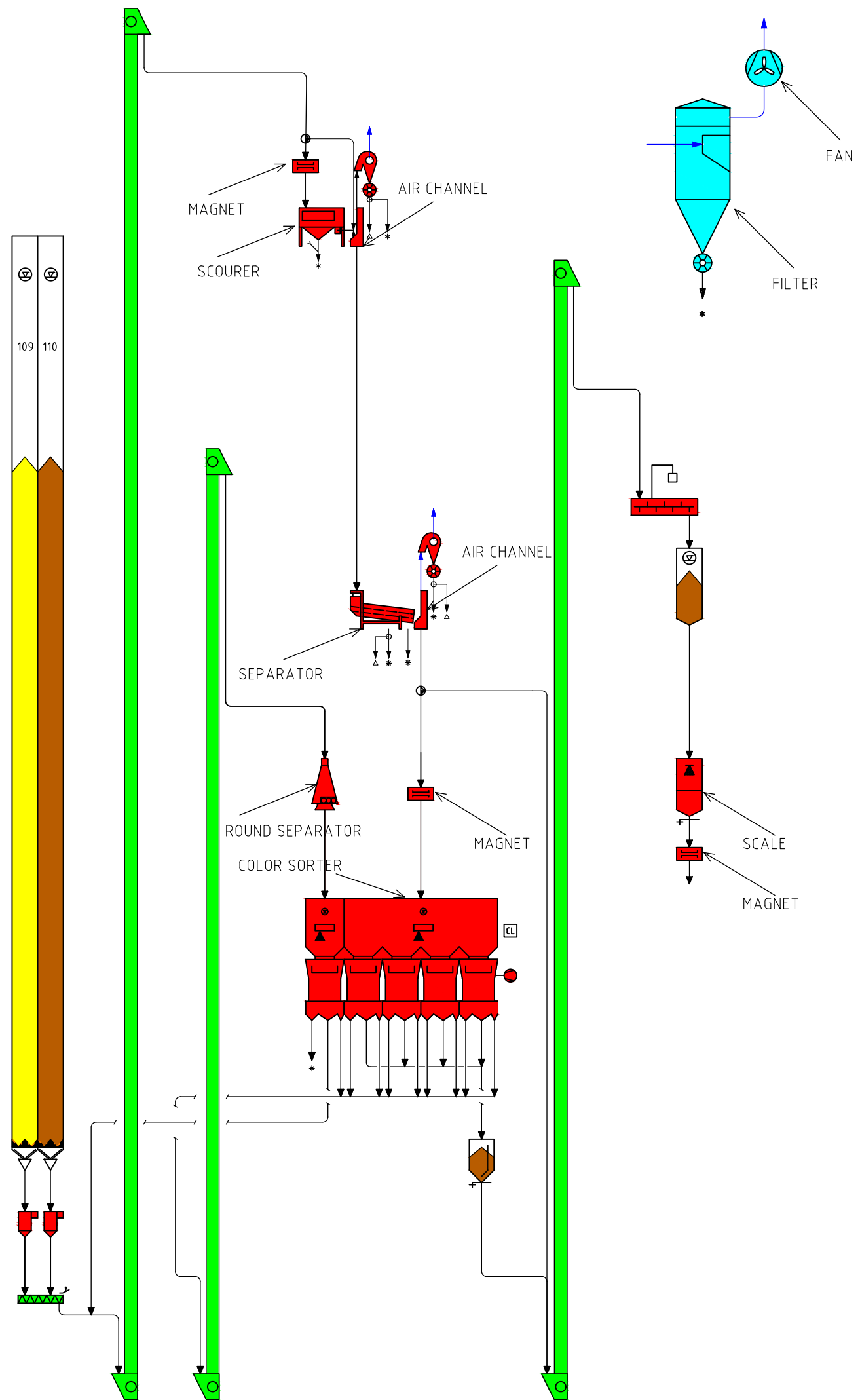

SECOND CLEANING

تکنولوژی دیاگرام آسیاب

- ▶ ظرفیت آسیاب
- ▶ وارپته گندم مورد استفاده در آسیاب
- ▶ خاکستر گندم
- ▶ خاکستر آردهای مورد نیاز تولیدی و دانه بندی
- ▶ آسیب نشاسته و توانایی جذب آب
- ▶ ضرایب ویژه در طول غلطک ها و سطح توری الک

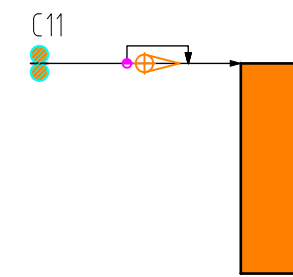
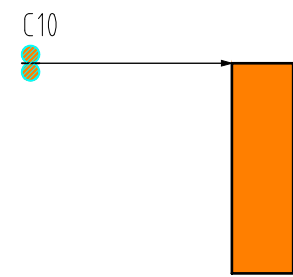
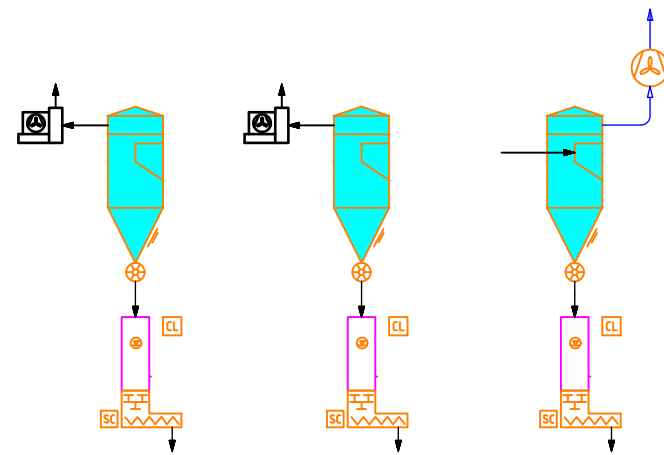
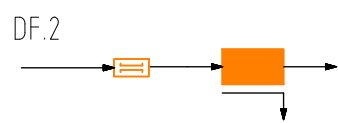
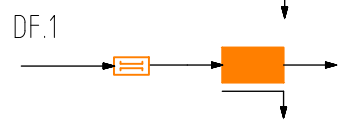
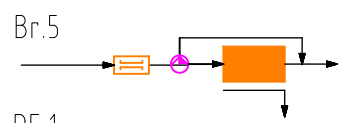
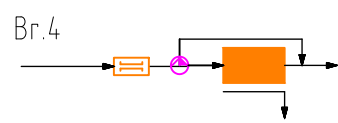
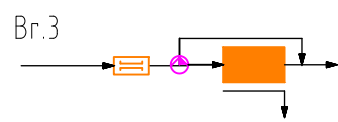
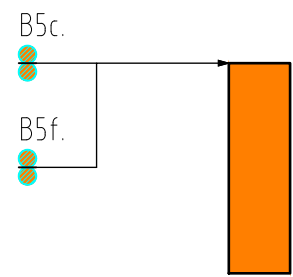
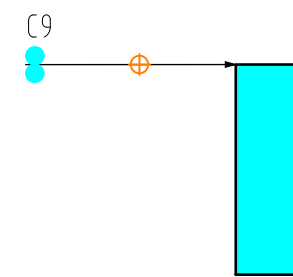
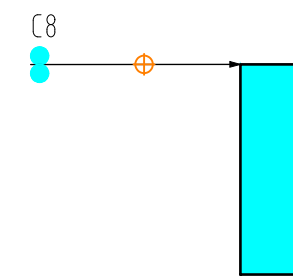
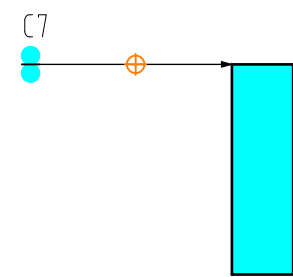
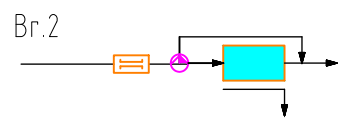
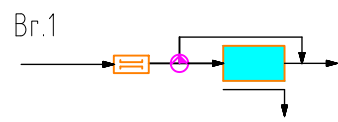
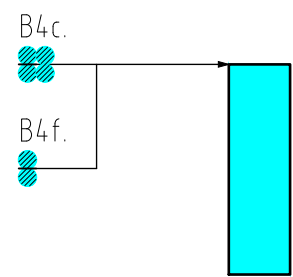
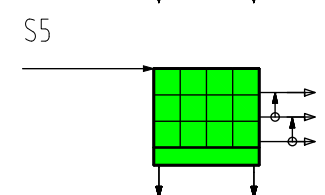
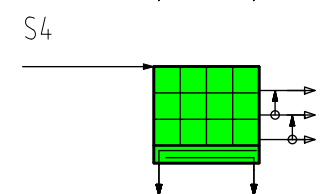
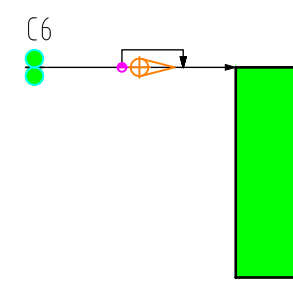
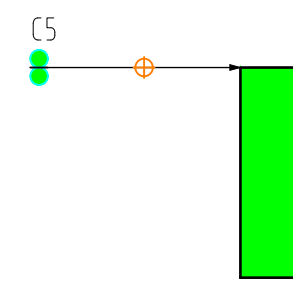
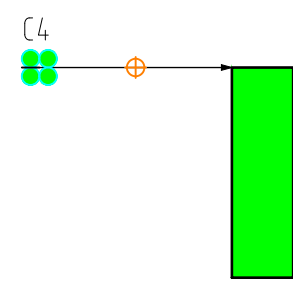
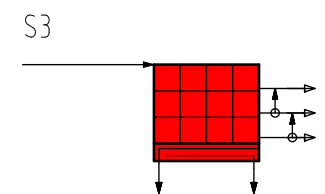
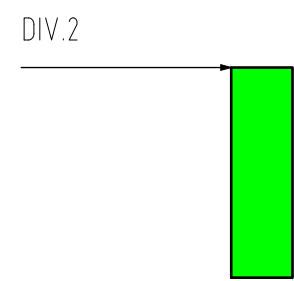
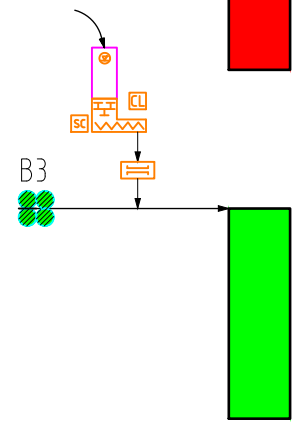
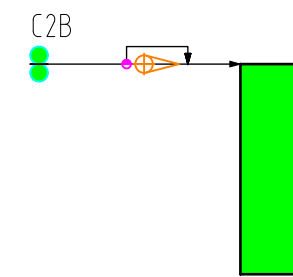
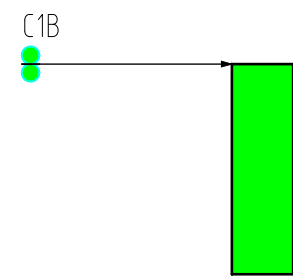
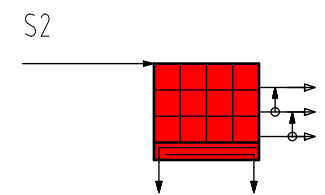
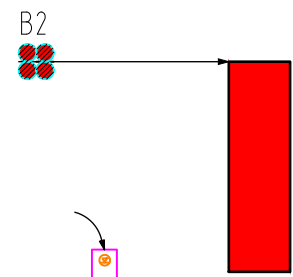
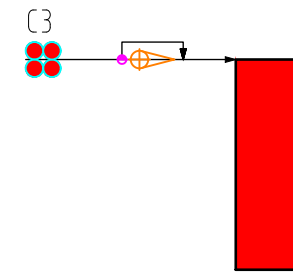
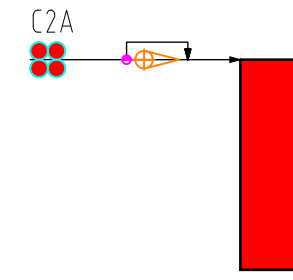
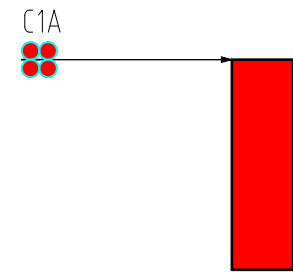
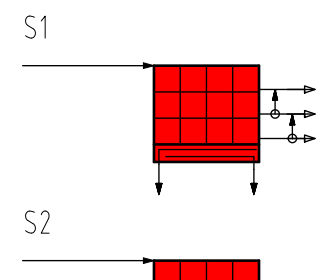
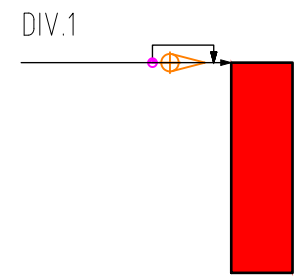
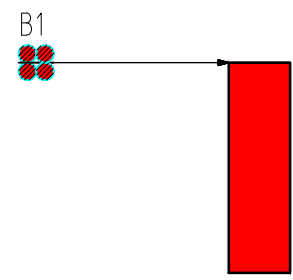

ONLY 4 ROLLER MILL

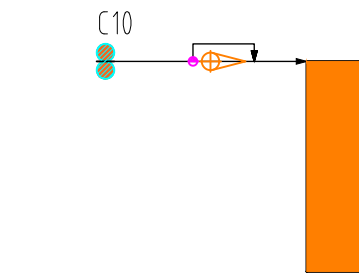
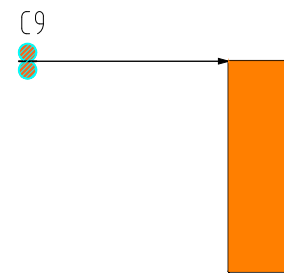
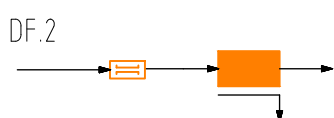
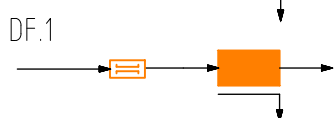
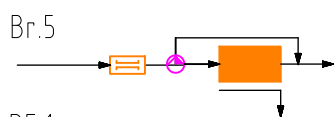
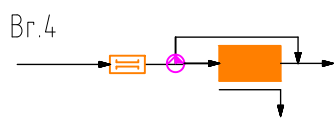
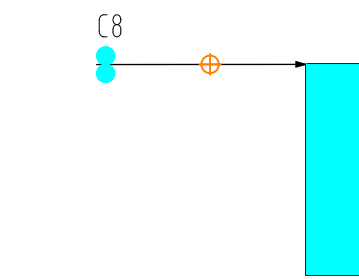
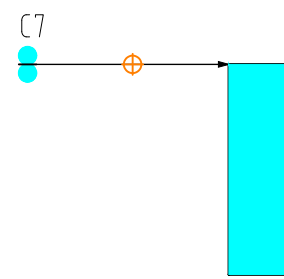
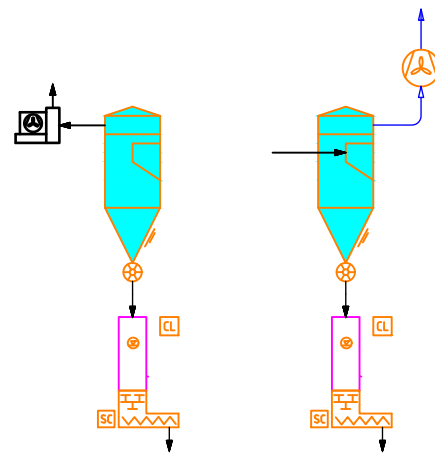
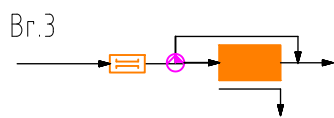
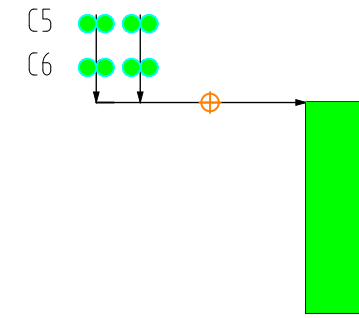
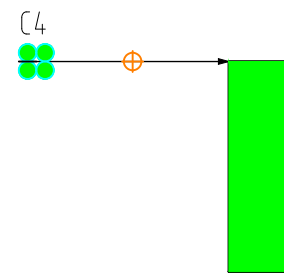
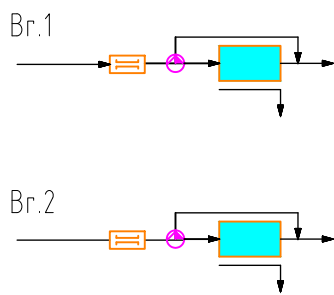
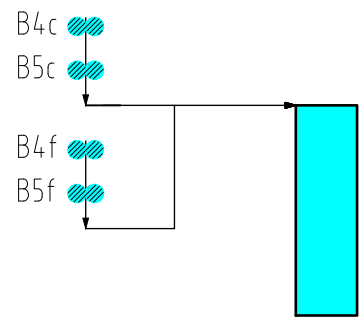
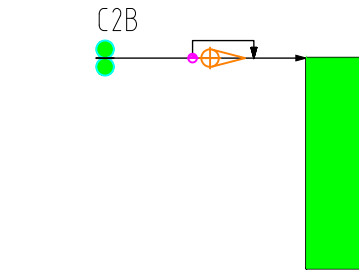
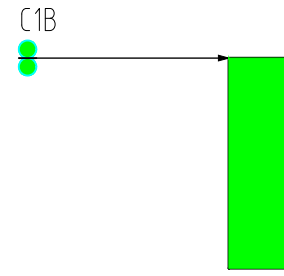
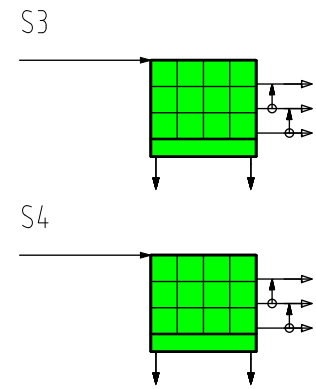
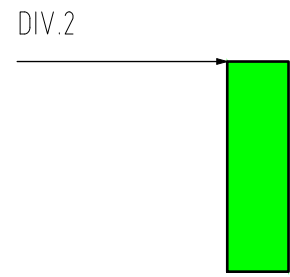
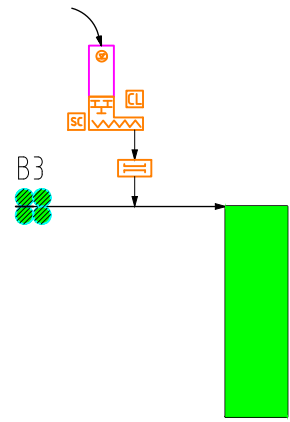
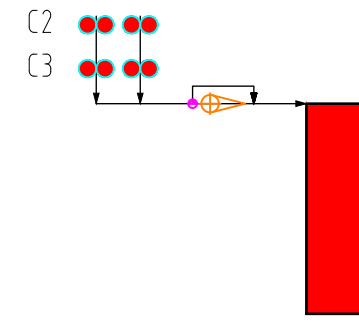
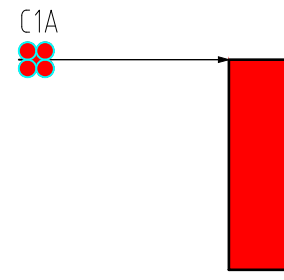
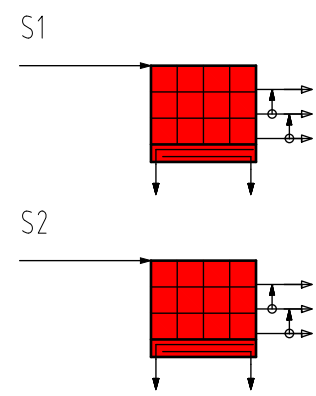
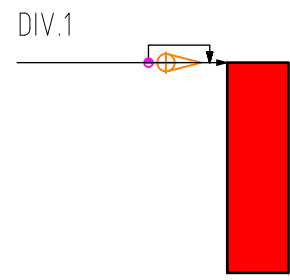
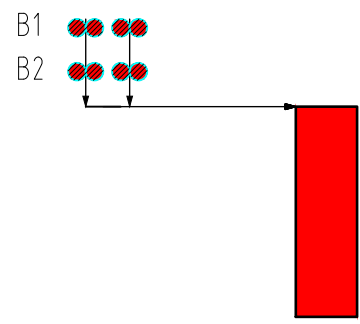

COMBINATION OF 4 & 8 ROLLER MILL

سیلوهای آرد

- ▶ قابلیت جابجایی و انتقال آرد داخل سیلوها
- ▶ امکان اختلاط آرد از زیر سیلوها
- ▶ الک کنترل آرد و آهنربا قبل از کیسه گیری و بونکر
- ▶ تجهیزات سیستم میکسینگ آرد جهت آردسازی تخصصی و افزودنی ها

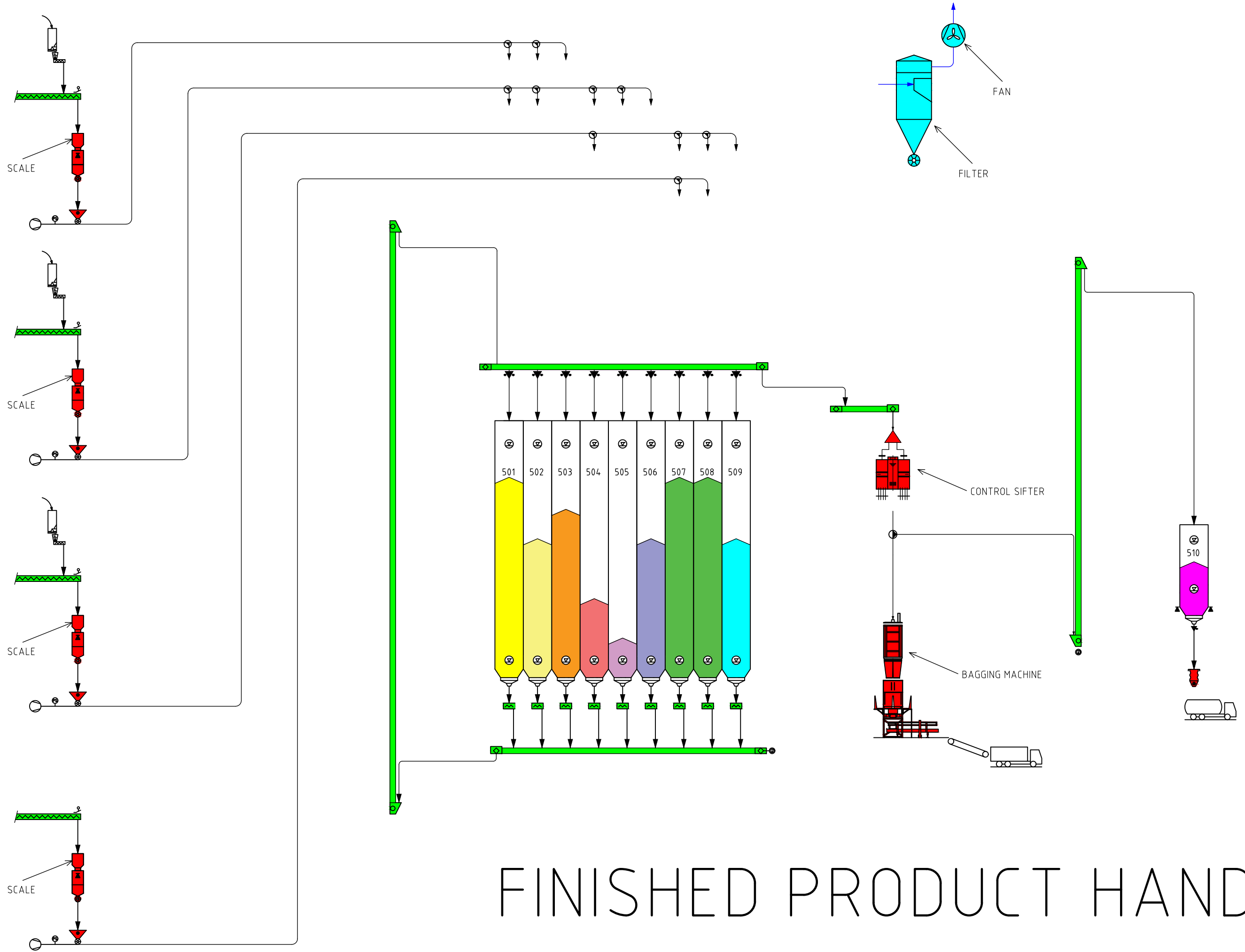

FINISHED PRODUCT HANDLING

